RW PPD

Portable Programming Device

by SALTO



The portable programming device is used to communicate data between the electronic **devices** and the PC on which we have designed a locking plan using the SALTO software.

WARNINGS:



1. We highly recommend making a back up copy of the Database you are working with, in order to be able to react in Emergency Opening situations.
2. After every battery change, always make an update of the escutcheon, also in case just 1 battery has been removed. This will maintain the date and time up to date.

THE DISPLAY

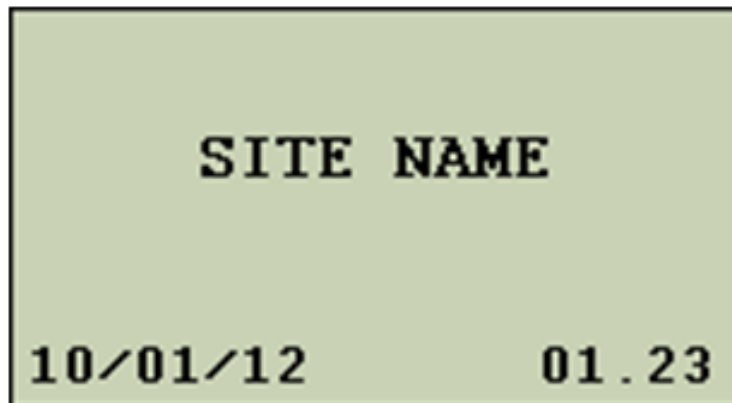

Immediately after the PPD is turned ON, the screen above will appear, showing the next information:

1. On the centre of the display, the SITE NAME the database belongs to.
2. On the bottom left corner, the PPD's MANUFACTURING date will be shown.
3. On the bottom right corner, the PPD's FIRMWARE VERSION will be shown.

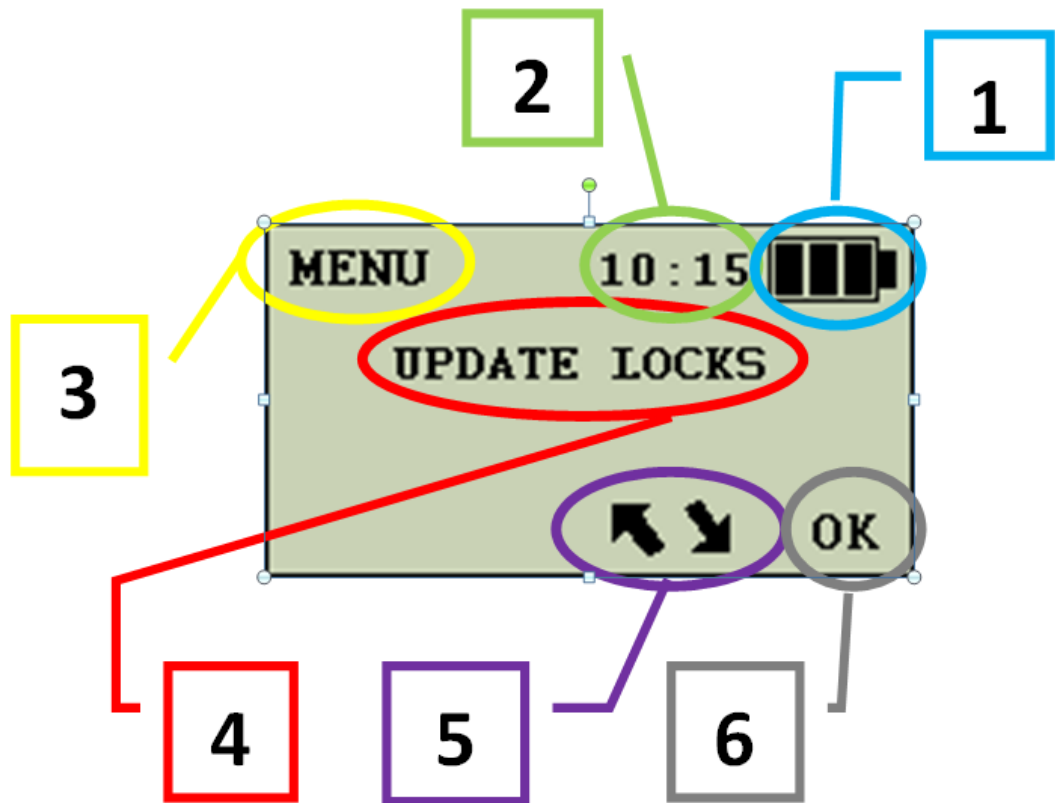

1. BATTERY STATUS AREA: The battery icon can show three different status:
Three bars: high battery level.
Two bars: medium battery level.
One bar: low battery level (battery replacement recommended).
Empty icon: very low batteries; there is not enough energy to do an emergency opening.
Flashing icon: batteries are completely dead.
2. TIME AREA: shows the current time.
 The time is taken from the PC's date and time setting. If the PPD is not updated they will not appear.
3. MENU LEVEL AREA: Shows the current menu.
4. MENU OPTION AREA: Shows the current menu option to be confirmed or to be cancelled.
5. ACTIVE KEY ICONS: Represent which PPD keys are active.
6. VALIDATION KEY: Press the OK key to validate or the ESC on the opposite side of the screen to go back.

PPD KEYS



This key has two functions. It turns the PPD on when pressed, and also works like the ESCAPE key, i.e., it returns to the previous screen. If pressed for 3 seconds, the PPD turns off. As soon as the PPD is turned on, an information window will appear during 2 seconds. This window will show the database name, the manufacturing date and the current PPD firmware version.



This key validates and confirms any menu option shown in the display when pressed. If pressed for 3 seconds, it will enable/disable the PPD back lighting.



This key is used to go through several menu options. (Upwards)



This key is used to go through several menu options. (Downwards)



This key is used to decrease the LCD contrast.



This key is used to increase the LCD contrast.

A PPD key function will be active if the relevant icon is shown in the display.

The PPD turns off automatically after two minutes without any activity.

The PPD back light will turn off automatically, after twenty seconds if no key is pressed.

CONNECTIONS

The PPD has two communication ports, located at the upper part of the PPD as described below:

1. PPD to PC Connector: located at the upper part of the PPD. This connector will allow the communication between the PPD and the PC.



- USB Connector: USB drivers are installed when installing the software. Use the provided USB cable, and plug it into any USB connector of the PC.

As soon as the PPD is connected for the first time, the PC will recognize the new device and will launch the drivers.

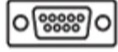
- SERIAL Connector: 
Connect the serial cable to any SERIAL port of the PC. Select an available COM port in the SALTO SW.
- 2. PPD to DOOR RJ11 female phone socket connector:
The telephone type connector (RJ11) is used to communicate with the electronic device.
- Connect to the Electronic device for data transfer:
Use the SALTO RJ11 connecting cable (provided), and plug the RJ11 telephone connector end into the PPD. Depending on the device's technology, there may be three different types of cables.
 - 1/ A 3 pins connector for Proximity and iButtons escutcheons.
 - 2/ An iButton connector for the iButton escutcheons.
 - 3/ A green card connector for Smart Chip Electronic escutcheons. (The golden contacts must be facing the chip side).
Note that there is no Smart Chip Technology on XS4 platform.

These connectors are used for the data transfer when connected to the readers.

WORKING WITH THE PPD

The PPD main menu has up to 7 different functions, depending on the information downloaded from the SALTO Software.

- **UPDATE LOCKS**

This PPD menu option is used for two functions: it shows the doors requiring an update, or, it automatically updates the electronic device connected to the PPD.

- **FIRMWARE DIAGNOSTIC**

It is used to do a firmware diagnostic of the escutcheon's electronic components

- **UPDATE FIRMWARE**

The PPD can be used to upgrade the firmware of some of the electronic components of the device, as reader, control boards and others.

- **COLLECT AUDIT TRAIL**

This PPD menu option is used to collect the audit trail events from one or several doors, transfer them to the database and then review the audit trail from the SALTO software.

- **EMERGENCY OPENING**

The PPD can be used for an emergency opening in case none of the carriers able to open the door, because of dead batteries, or a problem with the reader.

- **INITIALIZE LOCK**

This option of the PPD will allow the initialization of the new device or changing its identity, depending on what has been programmed in the SALTO software.

- **DIAGNOSTIC**

This PPD menu is used to extract information about the electronic devices.

DATA TRANSMISSION BETWEEN THE PC AND PPD

Once the locking plan design is done on the SALTO software, we must transfer all this information to the PPD, following the next steps to do so:

1. Connect the PPD to the PC using the USB cable or the serial cable (DB-9 connector), go to the main menu in the software and click on the CONNECT PPD icon.



2. A window will open. All the doors needing an update or not initialized yet will be selected automatically.

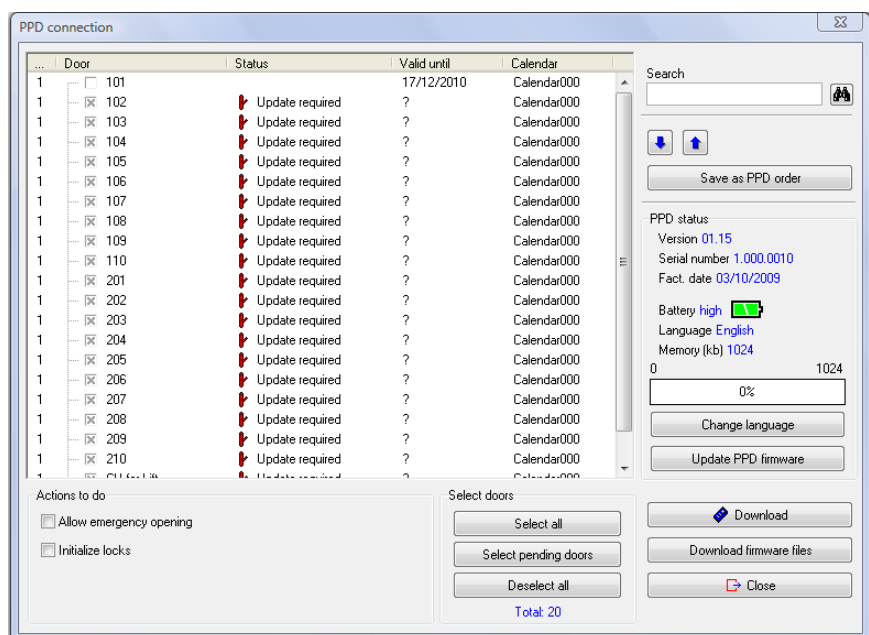

As shown on the window above, at the lower left corner, there is a box named ACTIONS TO DO where it is possible to select what action to do with the PPD.

- If ALLOW EMERGENCY OPENING is selected, this option will be available on the PPD main menu. If this option is selected by default, it is because it has been selected on the TOOLS/ CONFIGURATION/ GENERAL OPTIONS/ PPD tab, as shown on the picture just below.

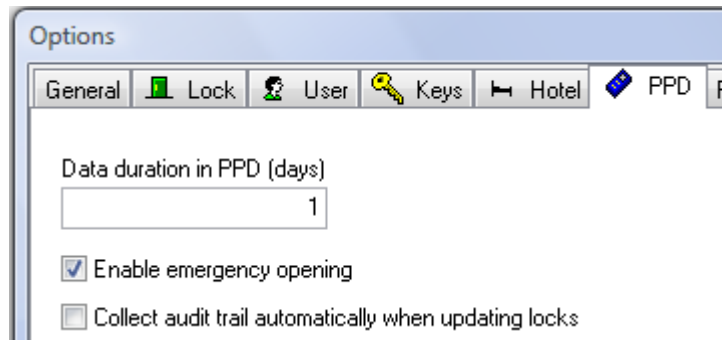

- If INITIALIZE LOCKS is enabled, this option will be available on the PPD main menu.

If any of these two options is selected, the PPD will only update the electronic device and automatically collect Audit Trails, in case the PPD is configured to do so in the TOOLS/ CONFIGURATION/ GENERAL OPTIONS/ PPD tab, as shown on the picture above.

3. When all the needed doors are selected, click on the DOWNLOAD button.

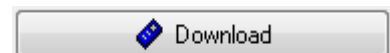

4. The data transfer from the PC to the PPD will take several seconds. Before disconnecting the PPD cable, wait until the progress bar reaches 100%.



NOTE that it is possible to change the PPD language, by clicking on the CHANGE LANGUAGE button. By default, the PPD's language will be the one used in the software.



NOTE: if the message "CONNECT TO LOCK" is shown in the PPD's display when trying to connect the PC with the PPD, the communication procedure will not work. Press the "C" key on the PPD to return to the previous screen and repeat the communication procedure.

UPDATING LOCKS

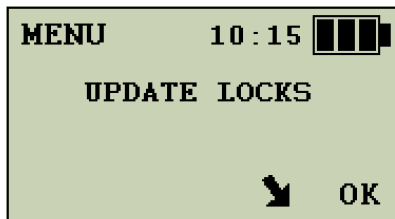

Some of the changes made on the locking plan must be transferred to the doors. In order to do so, it is necessary to pass the new information from the PC to the affected doors.

It is recommend updating all the doors every 3 months, to make sure the clock and the calendars are up to date.

- To load the PPD with the appropriate information, go to the “DATA TRANSMISSION BETWEEN THE PC AND PPD” section explained above.
- A window will open showing the doors that require an update.



Door	Status	Valid until	Calendar
1 101		17/12/2010	Calendar000
1 102	Update required	?	Calendar000
1 103	Update required	?	Calendar000
1 104	Update required	?	Calendar000
1 105	Update required	?	Calendar000
1 106	Update required	?	Calendar000
1 107	Update required	?	Calendar000



NOTE that when updating a device, it is not necessary to check any option into the ACTIONS TO DO box.

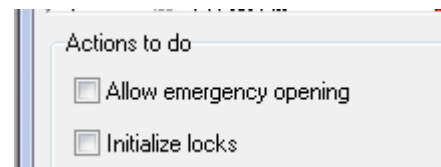

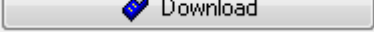
- Click on the **DOWNLOAD** button. 
- Once the progress bar reaches 100%, the data transfer is finished.
- Then unplug the PPD cable and go to the first set of electronic devices that require an update.
- Now connect the communication cable to the escutcheon. The PPD will turn on, recognize the door by itself and will start updating without the need to press any button.
- As soon as an escutcheon is updated, its name disappears from the LOCK LIST.
- After all doors are updated, (LOCK LIST will show the message "NOTHING TO DO"), connect the PPD to the PC and click on the CONNECT PPD icon to transfer the PPD information to the PC. By doing so, the software will be able to show the latest updated information about the battery status and also the escutcheons that still require an update.

FIRMWARE DIAGNOSTIC

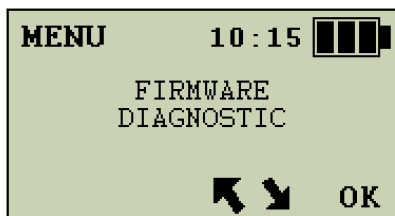

By connecting the PPD's cable to the reader and pressing OK, a diagnostic of the device's electronic components will be done giving the following information;

DEVICE: 00-37. This is the ID of the electronic part.

FIRMWARE: 04.06. This is the FW version of the device shown above (by a number)

In order to know what is the device number it is referring to, please check the Firmware list provided by SALTO.

UPDATE FIRMWARE

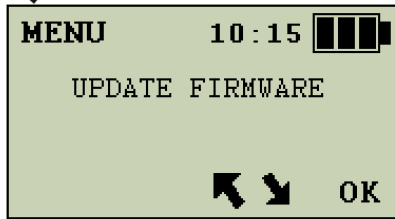

This PPD can also work as a firmware updaters. It can be a regular programmer or a firmware updaters. Using the SALTO software, into the “CONNECT PPD” window, click on the “Download firmware files” button,



and the following window will appear. Find and select the needed firmware files and add them to the PPD. Depending on the size of the firmware file, more or less files could be kept in the memory.



For more info about how to download firmware files into the PPD, see the software user manual.

In order to update the firmware on an electronic device, please follow the next steps:

- Turn the PPD on.
- Use the arrow keys to find the **UPDATE FIRMWARE** option and click OK.
- Select the firmware to upload, depending on the component to upgrade
- Hold the PPD connected until the process shown in the screen is finished.
- If another component needs a firmware update, find the correct file and repeat the process.

COLLECTING AUDIT TRAILS

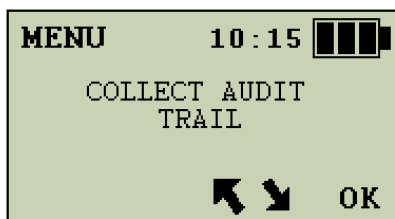

Events occurred on the escutcheon could be collected by using the PPD.

- Turn the PPD on.

- Use the arrow keys to go to the **COLLECT AUDIT TRAIL** option and press OK.
- **CONNECT TO LOCK** message will be shown.
- Connect the PPD to the electronic device using the communication cable and hold on for a few seconds while data transfer is finished.
- If the door has been previously initialized with a different DB the PPD will show the **ERROR, DOESN'T BELONG TO SYSTEM** message.
- When the collection is finished, the **NAME** of the door and **UPDATED** will be displayed on the screen.
- This procedure must be repeated for all doors for which the audit trail is needed.
- When finished, go to the PC and connect the PPD.
- In the software main menu, click on the **AUDIT TRAIL** icon. Then click on the **CONNECT PPD** button, to view the Audit Trail on the PC monitor.

EMERGENCY OPENING

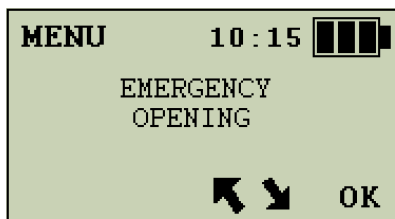

This PPD menu option is used to open a lock which has **run** out of batteries or if for any reason the reader do not react to the key.

The fact that the **EMERGENCY OPENING** option is available or not in the PPD main menu, depends on the set up in the software (TOOLS/ OPTIONS/ PPD menu)



WARNING: if this option is enabled by default, note that any unauthorized person taking the PPD will be able to open all building doors without using any key. This risk must be taken into account by the responsible of the building security.

In order to do an emergency opening, follow these steps:

- In the Pro Access software/ Connect PPD option, select the **ALLOW EMERGENCY OPENING** option in the **ACTIONS TO DO** section.

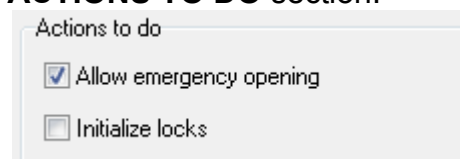

- Download data from the PC to the PPD.
- Take the PPD and go to the blocked door.
- Turn the PPD on and select the **EMERGENCY OPENING** option.
- Press the OK button and the **CONNECT TO LOCK** message will be displayed.
- Connect the PPD cable to the escutcheon and hold it for a few seconds (3 or 4).
- The motor will sound engaging the clutch, then press the handle and the PPD will give the message: **DOOR OPENED**.
- Replace the batteries and update the unit (via the PPD) with the current date and time data.
- If the door does not belong to the system, the **ERROR DOESN'T BELONG TO SYSTEM** message will be shown and the door won't open.

INITIALIZING THE ELECTRONIC FURNITURE

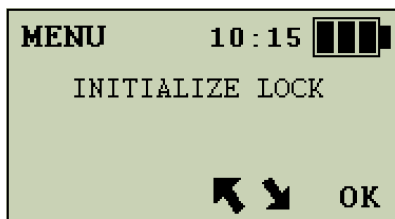

This PPD menu option is only used the first time that data must be transferred from the PPD to an electronic device. Initializing each set of devices in a system, transfers the identity given to each door in their working modes from the SALTO software. It transfers data as time-zones, calendars, automatic opening periods, blacklist and time and date. It is recommended to connect the PPD back to the PC after initializing the electronic devices, so the information in the software is updated and keeps it up to date with the actions done with the PPD.

In order to see this menu on the PPD, the INITIALIZE LOCKS option must be selected on the ACTIONS TO DO area in the SALTO software, in the CONNECT PPD window.

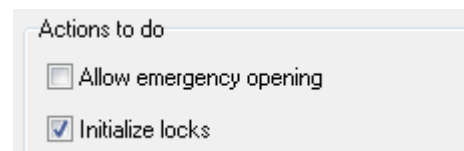

For any device initialization, follow these steps:

- Load the PPD with the locking plan from the SALTO software. Do not forget to select **INITIALIZE LOCKS** option in the **ACTIONS TO DO** section.

- Connect the communication cable to the PPD.
- Turn the PPD on by pressing the “C” key. Then **go to the INITIALIZE** option by using the arrows.
- Press OK and see the first door in the displayed list.
- Make sure the displayed name belongs to the electronic device to initialize (an error could result in the device being fitted to the wrong doors and access being incorrectly set up in a building).
- Press the OK key and the **CONNECT TO LOCK** message will appear.



NOTE: If the device has been working previously with a different database, the CLEAR button will have to be pressed at the same time the download (Initialization) from the PPD is done.

- Insert the cable into the electronic device. Hold it for a few seconds while the data transfer is working. If the transmission finishes successfully, an **INITIALIZED** message displayed.
- Repeat this procedure for the rest of the devices, being careful to assign the correct door names to every set.



NOTE: in order to know which sets of electronic devices are still pending for initialization, go to the **LOCK LIST** option in the PPD main menu where a list of doors to initialize will be shown.

- After the initialization is done, connect the PPD to the PC. Click on the software main menu icon **CONNECT PPD**. All data from the PPD will be uploaded to the software. Now the software will show the latest updated information about the devices, like battery status, doors requiring an update and the lock firmware.



NOTE that if a door that is already in use is initialized, its audit trail will be deleted.

DIAGNOSTICS

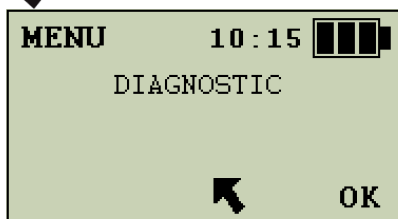

The PPD can be used to view a list of diagnostic information about each set of electronic devices.

Connect the communication cable to the PPD and visit the door you want to diagnose.

- Turn the PPD on by pressing the “C” key.
- The MAIN MENU message will be displayed.
- Using the arrow keys, go through the menu options to reach the DIAGNOSTIC option.
- Press the OK key.
- The message **CONNECT TO LOCK** will be displayed.
- Insert the cable contacts in the reader and hold in contact for 2 seconds.

All the electronic device information will appear in the PPD display. Use the arrow keys to go through the lines and see all diagnostics.

Below is an example of a diagnostic read out:

- **CONTROL** 01-35 (device number)
- FIRMWARE 04.06 (FW version)
- SERIAL NUM. 1-000-0058
- FACT. DATE 28/05/12
- MEMORY 16Kb (depending the model)
- BAT. STATE HIGH, MEDIUM or LOW
- **“NAME OF THE DOOR” or BELONG TO THE SYSTEM.**
- 11/06/12 16:46 Current date and time of the furniture.
- **READER** 00-90 (device number)

- **FIRMWARE** 03.16 (FW version)
- **RF MODULE** NO DATA (if the unit is not RF, if so, device num. and firmware will be shown)

In order to repeat the diagnose procedure with more doors, press the “C” key and go to the next door.

There is no problem if the PPD turns OFF while going to the next door because it will automatically turn ON when connecting to the next door. The PPD switches ON automatically for reiterative operations.

TECHNICAL FEATURES

4 x 12 digit LCD display
Case material: GREY ABS (Blue on old models)
Weight : 187.5 gr. (batteries included)
Dimensions : 164 x 70 x 31mm.
Packing: 310 x 235 x 58mm.

MAINTENANCE

The only maintenance required is the regular replacement of the batteries. The PPD uses 3x LR03 AAA batteries (1.5V each).



Note: These batteries are the same as those used in the SALTO escutcheons.

A battery set will last for approx. 2 years in the PPD if we make an update a week for every door in a 130 door building.

If you use the back lighting often, this battery life will be reduced.

In order to change the batteries, remove the cover located on the back of the PPD.





Note: when changing the batteries, you will have to reload the locking plan from the PC to the PPD because all data in the PPD memory is lost when the batteries are removed (or when batteries run out).



IMPORTANT NOTE FOR EUROPEAN COUNTRIES

This equipment was tested and corresponds to the EMC guidelines in accordance with the regulations 89/ 336/CEE.

Electronic Security Solutions, Inc.

<http://www.esslockingsystems.com>
dale@esslockingsystems.com | Phone: 847.767.3100
1225 Shiloh Boulevard, #69 | Zion, Illinois 60099

